

41L Bar Fridge

G41BFW15



Instruction Manual

12
MONTH

MANUFACTURER'S
WARRANTY

GVA

**THE 'V' STANDS
FOR VALUE.**

Contents

Guide to the Appliance	2
Caring for the Environment	3
Safety Information and Warnings	4
Getting Started	7
Operation Instructions	13
Troubleshooting	14
Care and Maintenance	16
Technical Specifications	18

Guide to the Appliance

NOTE: Due to the production's improvement, the unit you purchased may vary slightly from below sketch.

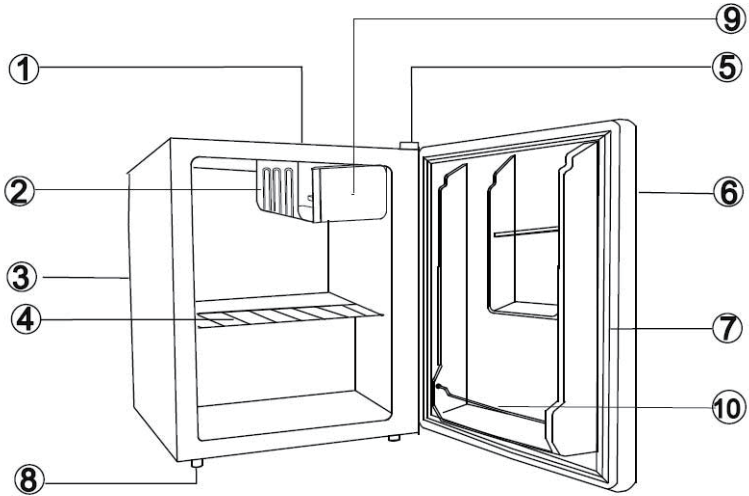

- | | |
|--------------------|--------------------|
| 1. Cabinet | 6. Door |
| 2. Cool Zone | 7. Gasket |
| 3. Thermostat Knob | 8. Adjustable Leg |
| 4. Shelf | 9. Cool Zone Cover |
| 5. Hinge Cover | 10. Bottle Rack |

Rear View

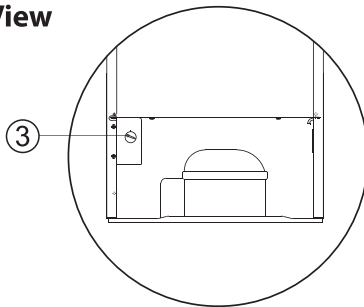

Caring for the Environment

Responsible disposal of the packaging

- The packaging of your appliance has been selected from environmentally friendly materials and can usually be recycled. Please ensure these are disposed of correctly.
- Plastic wrapping can be a suffocation hazard for babies and young children, please ensure all packaging materials are out of reach and are safely disposed of. Please ensure they are offered for recycling rather than throwing these materials away.

Responsible disposal of the appliance

- At the end of its working life, do not throw this appliance out with your household rubbish. An environmentally friendly method of disposal will ensure that valuable raw materials can be recovered and used again.
- Electrical and electronic appliances contain materials and substances which, if handled or disposed of incorrectly, could be potentially hazardous on the environment and human health.
- Observe any local regulations regarding the disposal of electrical consumer goods and dispose of it appropriately for recycling and recovery of the refrigerant. This appliance contains the flammable refrigerant isobutane (R600a) and cyclopentane (R141b) in the cabinet insulation, and must be disposed of in a separate waste collection. Contact your local authorities for advice on recycling facilities in your area.
- Take care not to damage the pipework at the back of the appliance before or during transportation so that the refrigerant gas cannot escape.
- The plug must be rendered useless and the cable cut off directly behind the appliance or the machine to prevent misuse.
- **DANGER.** Risk of child entrapment: When discarding a fridge or freezer, make sure to take off the door and the spring action or bolt catch. Leave the shelves in place so that children cannot easily climb in, get trapped inside and suffocate.

Safety Information and Warnings

Read this manual thoroughly before first use, even if you are familiar with this type of product. We have provided many important safety statements in this manual concerning the use of this appliance. Always read and observe all safety statements. They reduce the risk of fire, electric shock and injury when correctly adhered to.

Keep the manual in a safe place for future reference, along with the completed warranty card, purchase receipt and carton.

If applicable, pass these instructions on to the next owner of the appliance.



Pay particular attention to safety messages that follow this safety alert symbol or the words **DANGER**, **WARNING** or **CAUTION**. These words are used to alert you to a potential hazard that can seriously injure you and others.

The instructions will tell you how to reduce the chance of injury and let you know what can happen if the instructions are not followed.

DANGER means that failure to read this safety statement may result in severe personal injury.

WARNING means that failure to read this safety statement may result in extensive product damage or serious personal injury.

CAUTION means that failure to read this safety statement may result in minor or moderate personal injury, property or equipment damage.



CAUTION:
Flammable Gas

This symbol alerts you to take care as the appliance contains a flammable refrigerant. Do not expose it to high heat, sparks and open flames.

We assume no liability for any eventual damages caused by misuse of the appliance or noncompliance with the instructions in this manual.

Safety Information and Warnings



Installation

- **Heavy:** This appliance is heavy, take care when moving it. To avoid back or other injury, consider a two person lift or mechanical aid when installing it.
- **Location:** The room for installing appliance must be at least 1M³per 8g of refrigerant. The amount and type of refrigerant in the appliance can be found on the rating plate on the back of the appliance.
- **Moisture:** Install the fridge in an indoor area protected from wind, rain, water spray or drips.
- **Heat:** Do not install it next to an oven, grill or other source of high heat.
- **Ventilation:** To ensure proper ventilation, the front of the unit must be completely unobstructed. Keep any ventilation openings clear of obstructions. Choose a well ventilated area with temperatures above 16°C and below 43°C.
- **Refrigerant circuit:** Do not damage the refrigerant circuit.
- **Level:** Install the appliance level in order to ensure proper operation. Adjust the feet to level the appliance.
- **Pipes:** Make certain that the pipes are not pinched, kinked or damaged during installations. Check for leaks after connection.

Electrical safety

- **Voltage:** Make sure your outlet voltage and circuit frequency correspond to the voltage stated on the appliance rating label. Plug the bar fridge into a 220-240V, 50Hz, 3-prong, power outlet with a 15A fuse at the mains. The outlet must be properly earthed to the ground.
- **Separate circuit:** Do not use an adaptor; do not use an extension cord. We recommend you connect the bar fridge to a separate circuit serving only this appliance. This provides the best performance and prevents overloading the house wiring circuits that could cause a fire hazard from overheating. Use a power point that cannot easily be turned off accidentally.
- **Power cord:** Do not kink or damage the power cord. Do not leave it exposed or dangling. Secure it behind the unit so no one steps on or places anything on the cord or against it. Never unplug the unit by pulling the cord. Always grip the plug firmly and pull straight out from the power point.
- **Damaged cord:** Do not use a cord that shows cracks or abrasion damage along its length or at either end. If the power cord is damaged, it must be replaced by the manufacturer or its service agent. Contact the after sales support line to have it replaced.
- **Electrical work:** If the installation of this appliance requires any electrical work, make sure it is carried out by a qualified electrician.

Safety Information and Warnings



Usage conditions and restrictions

- This appliance is intended to be used in household and similar applications such as:
 - 1) Staff kitchen areas in shops, offices and other working environments;
 - 2) Farm houses and by clients in hotels, motels and other residential type environments;
 - 3) Bed and breakfast type environments;
 - 4) Catering and similar non-retail applications.
- Intended purpose: Do not use this appliance for anything other than its intended purpose, and only use it as described in this manual. Do not attempt to alter or modify this appliance in any way.
- Electrical type appliances: Do not use any such appliances inside the food storage compartments of the appliance, unless they are specifically recommended in this manual.
- Usage restrictions: The appliance is not intended for use by persons (including children) with reduced physical, sensory or mental capabilities, or lack of experience and knowledge, unless they have been given supervision or instruction concerning use of the appliance by a person responsible for their safety.
- Children: Supervise children to ensure they do not play with the fridge. Never allow children to operate, play with or crawl inside the bar fridge.

Cleaning and maintenance

- Disconnect: Unplug the bar fridge or disconnect power before cleaning or servicing. Failure to do so can result in electrical shock, injury or death. Do not connect or disconnect the electric plug when your hands are wet.
- Flames: Do not let open flames or ignition sources enter the appliance.
- Flammable/explosive substances: Never clean this appliance with flammable fluids. Do not store explosive substances such as aerosol cans with a flammable propellant in this appliance. The fumes can create a fire hazard or explosion caused by electric sparks.
- Solvents: Do not use solvent based cleaning agents or abrasives on the interior. These cleaners may damage or discolour the interior.
- Defrosting aids: Do not use mechanical devices, steam cleaners or other means to accelerate the defrosting process. Never use a sharp or metal instrument to remove frost as it may damage the cooling system and will void the warranty. We recommend using a plastic scraper.
- Service: Do not attempt to repair or replace any part of the bar fridge unless it is specifically recommended in this manual. Refer all other servicing to a qualified technician, or contact the after sales support line for advice on repair or replacement. It is hazardous for anyone other than an Authorised Service Person to service this appliance. In Queensland - the authorized Service Person MUST hold a Gas Work Authorisation for hydrocarbon refrigerants, to carry out Servicing or repairs which involve the removal of covers.

Getting Started

Before first use

- Unpack the appliance but keep all packaging materials until you have made sure your new bar fridge is undamaged and in good working order.
- Plastic wrapping can be a suffocation hazard for babies and young children, so ensure all packaging materials are out of their reach.
- Check to ensure you have all the parts listed, plus an instruction manual and a warranty certificate.
- Read this manual to familiarise yourself with all the parts. Pay particular attention to the safety instructions on the previous pages.
- Unwind the cord to its full length and inspect it for damage. Do not use the appliance if the appliance or its cord have been damaged. In case of damage, contact our after sales support line for advice on examination, repair or return of the damaged product.
- Make sure the bar fridge is disconnected from the power supply before cleaning the interior surfaces with lukewarm water using a soft cloth to remove any dust from transit and storage. Dry the appliance thoroughly.
- Your bar fridge has the capability of the door opening from the right or left side. If your setup requires reversal of the door swing, follow the instructions on page 9.

Overloading the fridge will affect cold air circulation and cooling performance. We therefore recommend you only load the fridge up to about 70% of its storage volume, always leave some space around food stored, and do not use containers that are too large and block ventilation openings.

Installing the bar fridge

- Before installing your new upright bar fridge, read all safety instructions in this manual, especially the sections on electrical safety and installation. Then follow the instructions below.
- This appliance is designed to be freestanding only and should not be recessed or built in.
- Place the bar fridge on a sturdy, level floor that is strong enough to support the unit when it is fully loaded.
- DO NOT install the appliance directly on carpeting or soft material. Carpeting must be removed or protected by a metal or wood panel beneath the appliance, which extends at least the full width and depth of the appliance. NOTE: Ensure that the appliance does not stand on the electrical supply cable. Parts which heat up should not be exposed. Whenever possible, the back of the appliance should be close to a wall but leaving the required distance for ventilation.

Getting Started

- Locate the bar fridge:
 - Away from direct sunlight, which may affect the acrylic coating.
 - Away from sources of heat (stove, heater, radiator, dishwasher, etc.), which may increase power consumption.
 - In an area without extreme cold ambient temperatures, which may affect cooling performance.
 - In a cool, well ventilated area, without excessive moisture and high humidity.
- Installing the unit in the coolest area of the room will save energy consumption and running costs.
- To ensure correct operation, this appliance must not be located where the temperature will be below 10°C or above 43°C.
- Ensure there are no obstructions that could prevent the fridge door from closing.
- To level the bar fridge, adjust the levelling legs at the bottom of the unit.
- The refrigerator must have at least 50mm clearance between the rear of the appliance and the wall, 25mm between the sides and wall, and the space above the top should be at least 25mm. Ensure that there is enough spacing to open the door to 160°.
- Before plugging in your new bar fridge, let it stand upright for approximately 2 hours. This will allow the refrigerant gases to settle into the compressor and reduce the possibility of a malfunction in the cooling system from handling during transportation.
- The Bar Fridge is suitable for connection to 220-240VAC 50Hz supply. The Bar Fridge must be plugged into a dedicated individual 220-240VAC main socket outlet.
- Plug the unit into an exclusive, properly installed and earthed wall outlet. Do not under any circumstances cut or remove the third (ground) prong from the power cord. If in doubt about your setup, direct any questions concerning power and/or grounding to a certified electrician.
- Do not use an extension cord or an adapter plug.
- Secure the bar fridge's supply cord behind the unit. Do not leave it exposed or dangling to prevent injury and accidental disconnection from the power supply.

NOTE: After plugging the appliance into a wall outlet, allow the unit to cool down for two to 3 hours before placing food in the refrigerator compartment.

Getting Started

This bar fridge can be opened from either the left side (as supplied) or right side to suit your individual installation requirements. If you want to open the door from the right side, follow the instructions below.

WARNING! Ensure the bar fridge is disconnected from the power supply when reversing door swing.

NOTE: Keep all parts you remove for re-installation of the door on the other side.

1. Tilt the unit slightly towards the rear and prop it securely. Two people are required to tilt the unit during the door reversal process.

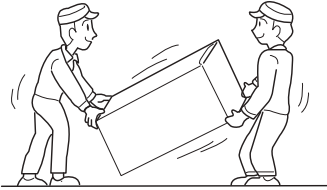

2. Remove the top right hinge cover.

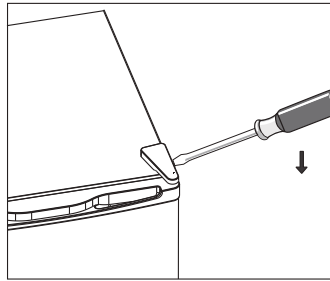

3. Undo the screws. Then remove the hinge bracket.

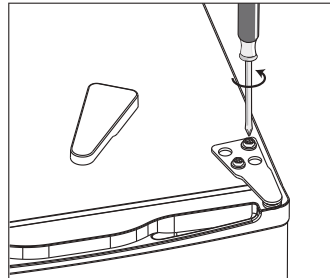

4. Remove the top left screw cover.

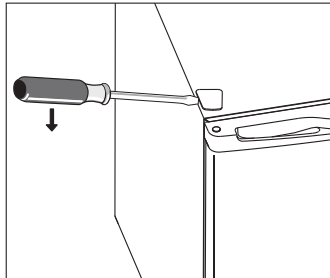

Getting Started

5. Move the core cover from left side to right side. And then lift the door and place it on a padded surface to prevent it from scratching.

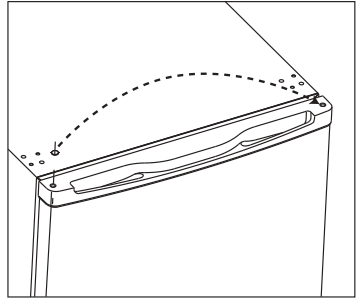

6. Remove the screws and bottom hinge. Then remove the levelling feet from both side.

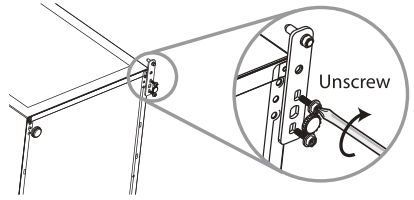

7. Unscrew and remove the bottom hinge pin, turn the bracket over and replace it.

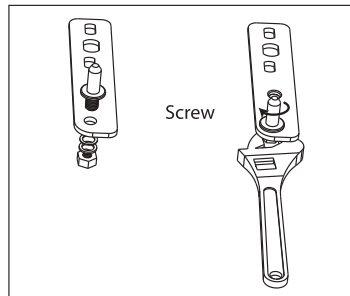
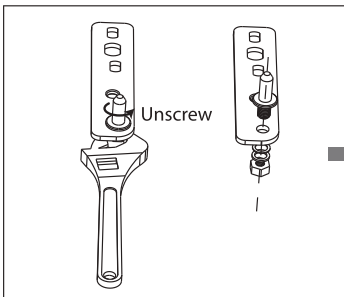

Getting Started

8. Refit the bracket fitting the bottom hinge pin. Replace both levelling feet.

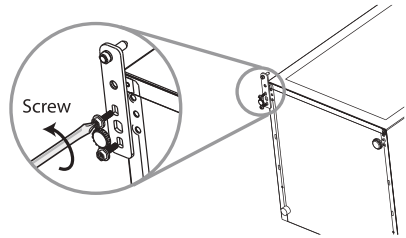

9. Place the door back on. Ensure the door is aligned horizontally and vertically so that the seals are closed on all sides before finally tightening the top hinge.
10. Insert the hinge bracket and screw it to the top of the unit.
11. Use a spanner to tighten it if necessary.

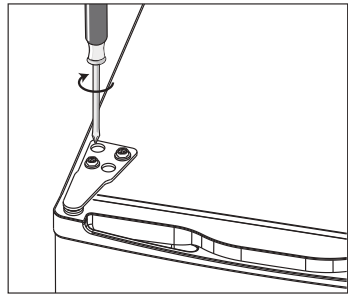

12. Put the hinge cover and the screw cover back.

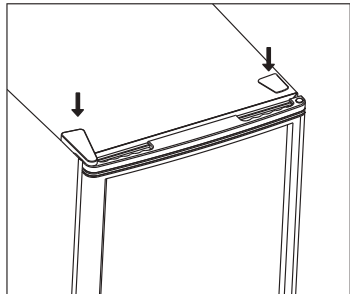

Getting Started

13. With the door closed, check that the door is aligned horizontally and vertically and that the seal is closed on all sides before finally tightening the bottom hinge. Re-adjust the levelling feet as needed.

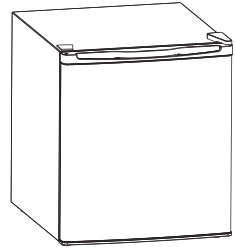

Operation Instructions

Temperature control

- The control for regulating the temperature inside the refrigerator is located in compressor compartment at the back of unit. .
- Position "0" means OFF.
- Turning clockwise in direction will turn the refrigerating unit ON.
- Position "1" means: Highest temperature, warmest setting.
- Position "5" means: Lowest temperature, coldest setting.
- At a low ambient temperature of around 16 °C, setting "1" should be selected.
- At ambient temperatures of around 25 °C, select setting "2-3". If you require a lower temperature, select setting "4" or "5".

NOTE: High ambient temperatures (e.g. on hot summer days) and a cold setting on the temperature regulator (position 5) can cause the compressor to run continuously. Reason: when the ambient temperature is high, the compressor must run continuously to maintain the low temperature in the appliance.

- The temperature will be affected by: Room temperature, how often the door is opened and location of the appliance.
- In determining the correct temperature control setting, all these factors have to be considered and some experimentation may be necessary.

NOTE: If the unit is unplugged, turned off or has lost power, you must wait three to five minutes before restarting the unit. If you attempt to restart before this time delay, the unit will not start.

Fresh food storage

The fresh food (refrigerator) compartment is suitable for short-term storage of fresh food. The temperature inside varies depending on the amount of food stored and the frequency of door opening.

In order to maintain good cooling efficiency and save energy, we recommend you do not open the door for too long or too often. Do not overload the bar fridge, and keep enough space around items for cold air flow. Do not block ventilation openings.

Normal Operating Sounds

The following noises are characteristic of refrigeration appliances:

Clicks: Whenever the compressor is switched on or off, a click sound may be heard.

Humming: As soon as the compressor is in operation, you may hear it humming .

Bubbling/Splashing: When refrigerant flows into thin tubes, you may hear bubbling or splashing noises. Even after the compressor has been switched off, this noise may still occur for a short time.

Troubleshooting

If you experience a problem with your bar fridge, check in the following table for solutions to help you solve the problem. If after these checks you still have a problem with your bar fridge, call the after sales support line for advice.

Problem	Possible cause
The fridge does not operate.	<ul style="list-style-type: none"> • It is not plugged in. Ensure it is properly plugged in and there is power at the socket (plug another appliance into the outlet to check). • The circuit breaker tripped or has blown a fuse. • The fridge temperature control is set to OFF. • A general power outage has cut power to your home (check the household lights).
The fridge temperature is not cool enough.	<ul style="list-style-type: none"> • The room temperature is hotter than normal. • A large amount of food has been added at once. • The door is opened too often. • The door is not closed completely. • The temperature control is not set correctly. • The door gasket does not seal properly.
There are vibrations.	<ul style="list-style-type: none"> • The fridge is not level.
The fridge seems to make too much noise.	<ul style="list-style-type: none"> • A rattling noise may come from the flow of the refrigerant, which is normal. A popping and crackling noise may be caused by the contraction and expansion of the inside walls. • The fridge is not level, or is touching other furniture. • Bottles or packages inside the fridge are touching each other.
The door will not close properly.	<ul style="list-style-type: none"> • The fridge is not level. • The door was reversed and is not properly installed. • The gasket is dirty or bent. • The shelves, racks or crisper are out of position.
The fridge door will not open.	<ul style="list-style-type: none"> • If the door has just been opened, leave it for a few minutes to allow the air pressure to equalise before trying again.
Moisture forms on the inside or outside walls of the bar fridge.	<ul style="list-style-type: none"> • Hot and humid weather increases the internal rate of frost build-up. This is normal. • Open the door less often and make sure it is always properly closed.

Troubleshooting

The external fridge surface is warm.	<ul style="list-style-type: none">•The exterior walls can be warmer than room temperature. This is normal while the compressor works to transfer heat from inside the fridge cabinet.
Excessive frost and ice has built up.	<ul style="list-style-type: none">•The fridge door has been left open.•Something is preventing the door from closing.•The door gasket is dirty or damaged.•Make sure to defrost the fridge regularly.
The compressor runs continuously.	<ul style="list-style-type: none">•The temperature is set too cold: select a lower (warmer) setting.•The door is open, or something is obstructing proper door closure.•The door gaskets are worn, dirty or damaged.•Large quantities of food have been added to the fridge.•The room temperature is hotter than usual.

Care and Maintenance

Defrosting the bar fridge

When? For the most efficient operation and minimum energy consumption, defrost the bar fridge when the frost accumulated on the evaporator is about 5mm thick.

How? Turn the thermostat dial to the [0] position and unplug the bar fridge. Remove perishable food items from the fridge and keep them in another fridge or cooler bag to protect the food.

Defrosting usually takes a few hours. After defrosting, dry the food compartments and return the thermostat dial to the desired position.

To defrost quickly, remove all foods from the fridge and leave the door open.

CAUTION: Do not use boiling water because it may damage the plastic parts. Never use a sharp or metallic instrument to remove frost as it may damage the cooling system. Use a plastic scraper, if required.

Cleaning the bar fridge

- **CAUTION:** Before cleaning the fridge, make sure to turn the temperature control to the [0] position, unplug the bar fridge and remove the food and shelves.
- Wash the inside surfaces with a warm water and baking soda solution. The solution should be about 2 tablespoons of baking soda to 1.2L of water. Wring excess water out of the sponge or cloth before cleaning around the temperature control or any electrical parts.
- Clean the shelves and inside fridge, as well as the outside of the fridge, with a mild detergent solution and warm water. Rinse and dry thoroughly.
- Never use acids, chemical thinners, petrol, benzene or the like for cleaning any part of the bar fridge.
- It is advisable to periodically clean the refrigeration system at the back of the appliance with a duster or vacuum cleaner.

Power failure

Most power failures are corrected within a few hours and should not affect the temperature of your fridge if you minimise the number of times the door is opened. If the power is going to be off for a longer period of time, take appropriate steps to protect your food.

Care and Maintenance

Energy saving tips

- Place the fridge in the coolest area of the room, away from heat-producing appliances and out of direct sunlight.
- Let hot foods cool down a little before placing them into the fridge. Overloading the fridge forces the compressor to run longer.
- Wrap foods properly and wipe containers dry before placing them in the fridge. This cuts down on frost build-up inside the fridge.
- Do not line any fridge storage bin with aluminum foil, wax paper or paper towels. Liners interfere with cold air circulation, reducing cooling efficiency.
- Do not leave the fridge door open for longer than required.

When away on holidays

- Short holidays: leave the fridge operating during vacations of less than three weeks.
- Long holidays: if the appliance will not be used for several months, remove all food, unplug the unit and thoroughly clean and dry the interior. To prevent odour and mould growth, block the door open slightly.

Moving the bar fridge

- Remove all food from inside the fridge, tape the door shut and securely tape down all loose items inside. Turn the levelling feet up to the base.
- We recommend moving the fridge in its original packaging. Otherwise, make sure to protect the outside of the fridge with a blanket or similar item during transportation.
- Do not apply force on any external part such as pipes, condenser or door when moving.
- Ensure the fridge stays secure in an upright position; do not tilt it for more than 45° from upright.

Switching off the appliance

To switch off the appliance, turn the temperature regulator to position "0". If the appliance is not going to be used for an extended period:

- Remove all refrigerated items
- Switch off the appliance by turning the temperature regulator to position "0"
- Remove the mains plug or switch off or disconnect the electricity supply.
- Clean thoroughly.
- Leave the door open to avoid the build up of odours.
- Once the unit has been turned off, allow the unit to settle down for about 10 minutes before turning the unit on. This will prevent the compressor from being damaged.

Technical Specifications

- Model: G41BFW15
- Group: 2 (Refrigerator)
- Product dimension WxDxH : 460mm x 510mm x 528mm
- Total gross volume: 41L
- Total storage volume: 38L
- Fresh-food compartment storage volume: 33.5L
- Special compartment storage volume: 4.0L
- Climate class: T
- Rated voltage: 220-240V~
- Rated Frequency: 50Hz
- Rated Current: 0.55A
- Star Rating: 1
- Energy consumption: 249 kWh per year



Double
Insulated



E2284



Indoor
Use



Read
Instructions



**THE 'V' STANDS
FOR VALUE.**

M.E.W. (Australia) Pty Ltd

15 Vaughan Street

Essendon Fields VIC 3041

ACN 152 719 036

1300 725 885

customercare@gvaproductions.com.au

gvaproducts.com.au

While every effort has been made in the preparation of this instruction manual, the publishers cannot be held responsible for the accuracy of the information contained herein or any consequences arising from it.